

Uniclass L4423			
CI/SfB			
	(42)	X	(J4)



Exclusive UK distributor of

inpro[®]

IPC[®] Door + Wall
Protection Systems

Protecting

Places



As the market leader with over 30 years experience protecting places for health, education and public buildings - Intastop is your ideal partner. We provide the solution to satisfy a range of wall protection requirements for your buildings.



For effective protection of buildings we offer a range of solutions that will minimise maintenance costs whilst providing an aesthetically pleasing look which can be tailored to suit any colour scheme or brand requirements.



Contents

Products

IPC® Handrails & Combi-Rails	06-09
IPC® Wall Guards	10-13
IPC® Bed Head Protection	14-15
IPC® Corner Guards	16-18
Soft PVC Corner Guard	19
Sanparrel™ Sheet	20-21
Aspex® Impact Protection Sheet	22
Heavy Duty Rubber Wall/Corner Protection	23
Protecting Doors & People	24
Training Centre	25
IPC® Product Characteristics	26
The colour range	27



Our Values



To protect Doors, People and Places through dynamic product innovation and effective solutions whilst continuing to achieve outstanding customer service.

We design and manufacture innovative products for the door environment and surrounding surfaces.

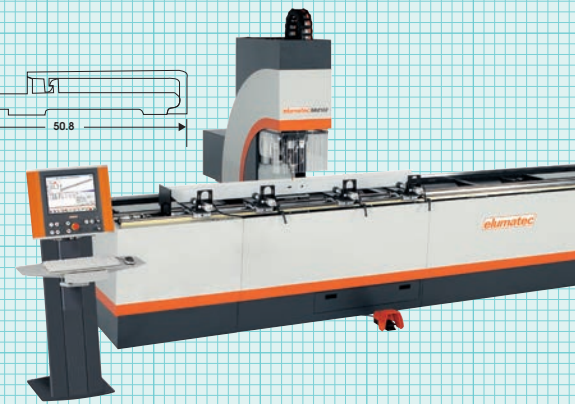
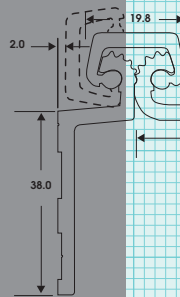

Our door solutions safeguard the health, security and privacy of people in high traffic public spaces and the health care sector.

Our products protect and enhance the aesthetic appearance of places. This extends the life of interior decor and therefore reduces ongoing maintenance costs.



By adopting open lines of communication with our existing and potential customers we understand requirements and provide innovative solutions via product research, development and in-situ testing. Each product is designed to provide a range of practical, technical and commercial solutions.

Manufacturing Excellence

Intastop operates a lean manufacturing continuous improvement programme. Utilising the latest machines, MRP systems and production processes we ensure deliveries are on time and stocks are at

sufficient levels to meet our customers demand. Products are quality checked on line and production managed to meet demand and our customer service charter.



Customer Service

Offering a complete solution from design through to on-site installation support, Intastop's expertise in both aluminium and PVC-u in the protection of doors and walls allows us to provide a solution to meet your needs. Supporting you regionally with dedicated internal and external support

we are on hand to provide technical advice, quotations and face to face visits. Our integrated system manages quote through to delivery to ensure prices, invoices and despatches are accurate, timely and completely visible providing you with the support and service you expect.

Environmental & Recycling

Intastop operates a stringent environmental policy in which all residual manufacturing materials such as waste aluminium and PVC-u are recycled, along with office paper and other wastes.

All our aluminium products contain 99% recycled content to help your buildings reduce their environmental impact.



IPC[®] Handrails & Combi-Rails

Support, guidance
and protection.



Impact resistant



Resistant to fungal
& bacterial growth



Meets Equality Act 2010
& HBN 00-04

Wall Mounting Handrails offer a high level of direct pedestrian guidance and rest support for the elderly, infirm and disabled. With a larger surface than handrails, Combi-Rails are primarily designed to offer protection against impact from wheeled traffic.

They are also designed with comfortable grip dimensions to provide pedestrian support. In addition, the Wall Guard is a textured finish to disguise the effects of damage whilst the handrail is a smooth finish to meet the requirements of HBN 00-04.

Many of our handrails are designed to meet guidelines BS8300:2009 + A1:2010.

Features

Offers support and guidance.
Comfortable grip diameter and thumb groove.
Option available designed to meet the Equality Act 2010 and HBN 00-04 guidelines.

Finishes

Standard finish is PVC-u, available in a wide range of colours.

Benefits

Keeps patients and staff safe by giving them handrail support.
Provides comfortable safe grip and not cold to the touch.
Maintains a hygienic safe environment.
Aids visually impaired people with colour contrast to the wall.
Reduces maintenance costs by preventing wall damage.





Handrail options



Aluminium retainer

Aluminium retainer and splice provides structural stability and allows extended lengths over 3.66m.

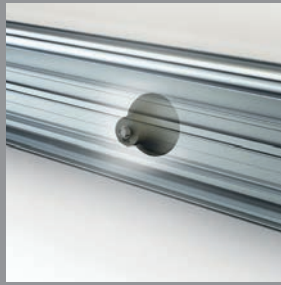

Mounting bracket

Mounting bracket keeps hands a safe distance from the wall.

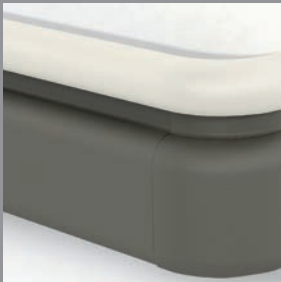

Cover

Covers are available in a variety of colours to coordinate with other interior finishes.

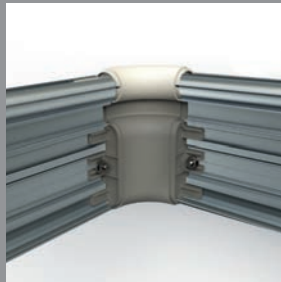

Inside/outside corners

Inside/outside corners provide a smooth transition for corner applications.



Returns finish

Returns finish gives the handrail installation a professional look.



Add a reveal

Add a reveal as a decorative element, standard with every Woodland Handrail order.



IPC® Handrails & Combi-Rails

Support, guidance and protection.

 Designed to meet the Equality Act 2010 and HBN 00-04 guidelines

 Impact resistant

 Easy to clean covers resist fungal and bacterial growth



910 Handrail

Order code	Description	Size (mm)	Length (mm)
I-HR-910	Handrail - Aluminium retainer & PVC-u Cover	38 grip dia.	3660



 Solid Wood option available

 50mm standoffs available upon request.

940 Handrail Smooth Finish

Order code	Description	Size (mm)	Length (mm)
I-HR-940	Handrail meets HBN 00-04 Guidelines	40 grip dia.	3660

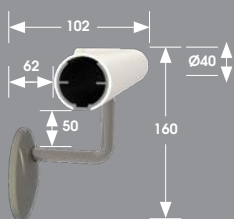

 HBN 00-04

 50mm standoffs standard.

 Brackets available as brushed stainless steel or aluminium.

800 Handrail

Order code	Description	Height (mm)	Length (mm)
I-HR-800	Combined Handrail - Aluminium retainer & PVC-u Cover	140	3660



 Ligature-resistant bracket and 50mm standoffs available upon request.

910 Handrail

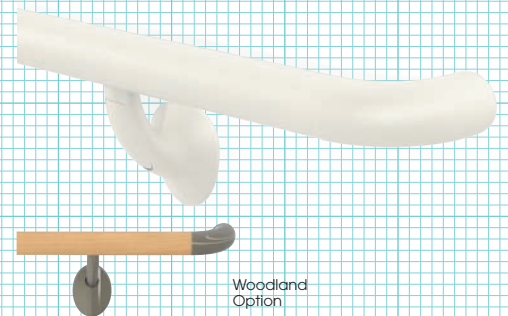

Woodland Option

940 Handrail Smooth Finish

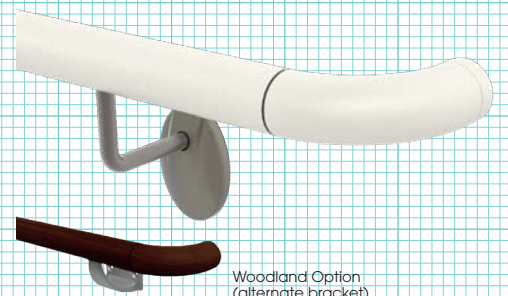

Woodland Option (alternate bracket)

800 Handrail



Woodland Option





1000 Handrail



1000 Handrail

Order code	Description	Height (mm)	Length (mm)
I-HR-1000	Combined Handrail - Aluminium retainer & PVC-u Cover	110	3660



Ligature-resistant bracket and 50mm standoffs available upon request.

1200 Combined Handrail

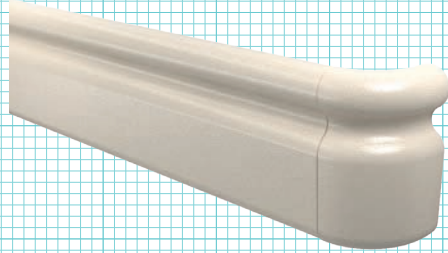

1200 Combined Handrail

Order code	Description	Height (mm)	Length (mm)
I-HR-1200	Combined Handrail - Aluminium retainer & PVC-u Cover	159	3660



Ligature-resistant bracket and 50mm standoffs available upon request.

3130 Oval Combined Handrail

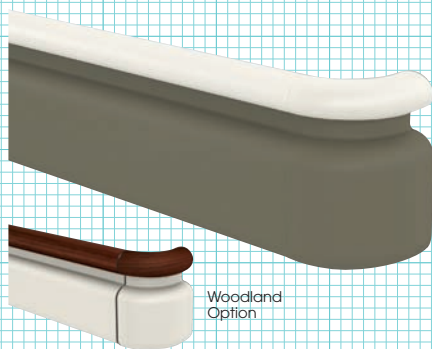

3130 Oval Combined Handrail

Order code	Description	Height (mm)	Length (mm)
I-HR-3130	Oval Handrail - Aluminium retainer & PVC-u Cover	159	3660



Ligature-resistant bracket and 50mm standoffs available upon request.

3400 Combined Handrail

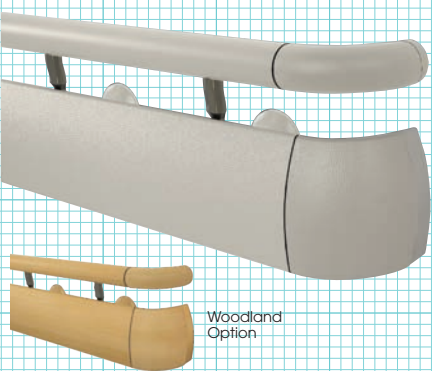

3400 Combined Handrail

Order code	Description	Height (mm)	Length (mm)
I-HR-3400	Combined Handrail meets HBN-00-04 guidelines	217	3660



50mm standoffs available upon request.

Solid Wood option available

IPC[®] Wall Guards

Superior impact protection
against wheeled traffic.



Stylish design

Wall Guards can be fixed to offer direct protection at specific points of impact, or at alternative levels on the wall for indirect protection. For strong substrates, easy-to-fix brackets are recommended as a cost effective option. Alternatively a continuous retainer can be used for severe duty applications or for bridging gaps such as wall glazing.

Features

Impact resistant.

Internal impact bumper (optional) provides superior impact absorption.

Stylish design.

Benefits

Reduces maintenance costs by preventing wall damage.

Protect severe duty areas.

Enhances visual environment.

Aid visually impaired people with colour contrast to the wall.

Finishes

Standard finish is PVC-u, available in a wide range of colours.



Retainer Choices

- Continuous Bracket
- Infinity Bracket



Available in a wide
range of colours

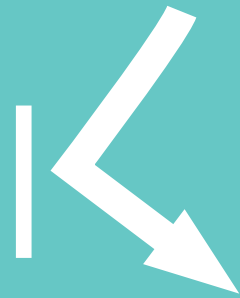

Impact resistant



Wall Guard overview

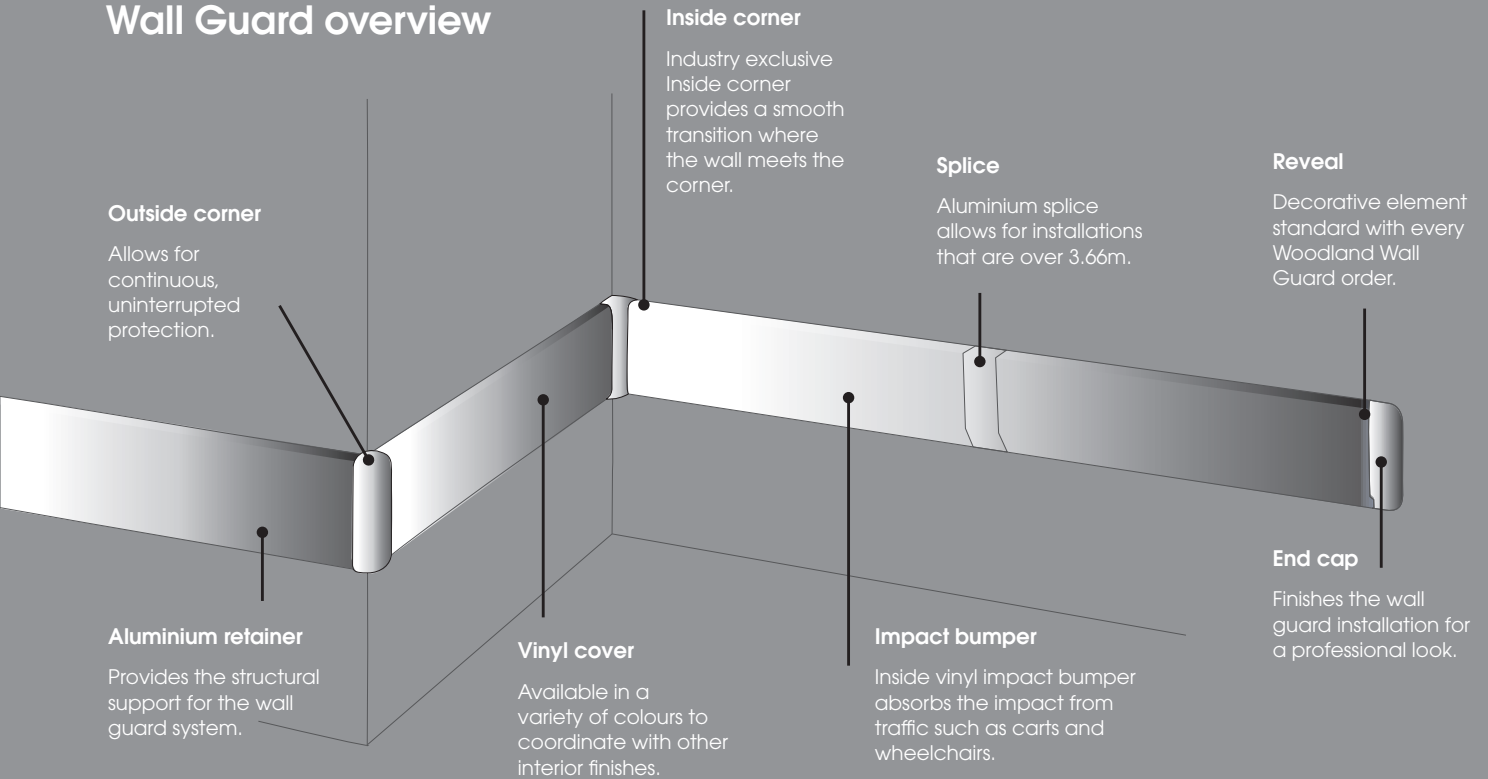

IPC® Wall Guards

Superior impact protection against wheeled traffic.

 Impact resistant

 Stylish design

 Available in a wide range of colours



2500 Chair Rail

Order code	Description	Height (mm)	Length (mm)
I-WG-2500	Chair Rail	50	3660

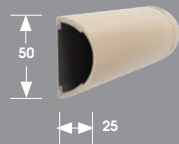

2500 Chair Rail



1300 Wall Guard

Order code	Description	Height (mm)	Length (mm)
I-WG-1300	D-Shaped Wall Guard	103	3660

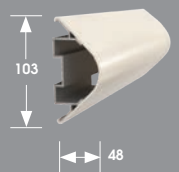



1300 Wall Guard

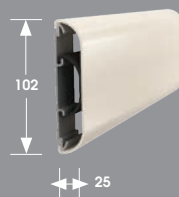

1400 Wall Guard

Order code	Description	Height (mm)	Length (mm)
I-WG-1400	Wall Guard	102	3660



 Retainer Choices
 • Continuous Bracket
 • Infinity Bracket

1400 Wall Guard





1500 Silhouette Wall Guard

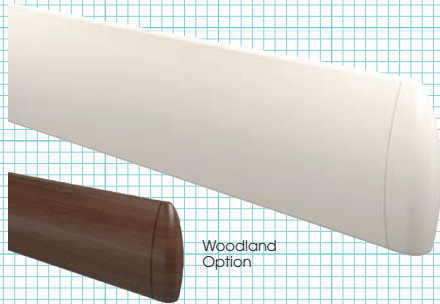

1500 Silhouette Wall Guard

Order code	Description	Height (mm)	Length (mm)
I-WG-1500	Silhouette Wall Guard	127	3660



- Retainer Choices
- Continuous Bracket
 - Infinity Bracket

700 Wall Guard

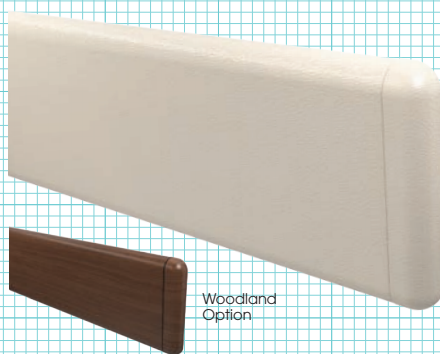

700 Wall Guard

Order code	Description	Height (mm)	Length (mm)
I-WG-700	Wall Guard	197	3660



- Retainer Choices
- Continuous Bracket
 - Infinity Bracket

1800 Wall Guard

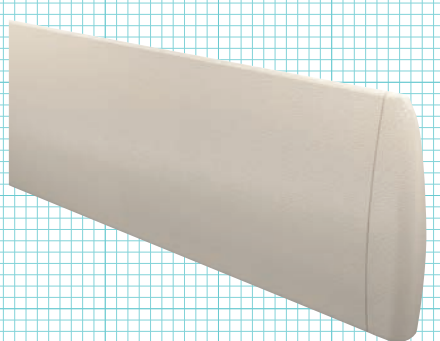

1800 Wall Guard

Order code	Description	Height (mm)	Length (mm)
I-WG-1800	Teardrop Wall Guard	203	3660



- Retainer Choices
- Continuous Bracket
 - Infinity Bracket

IPC® Bed Head Protection

Protects vulnerable walls and equipment from bed impact damage.

 Impact resistant

 Easy to install

 Available in a wide range of colours

Improving the environment for patients, staff and visitors, Bed Head Protectors are ideal against severe impacts, holding beds away from the wall to prevent obstruction and/or damage to critical wall-mounted equipment.

Bed Head Protectors fix vertically to the wall in pairs for continuous protection when beds are raised or lowered and can also be used as chair protectors.

Can be fitted vertically as a pair or horizontally as a continuous run.

Features

- Impact resistant.
- Easy to clean covers resist fungal and bacterial growth.
- Pre-cut packaged system.

Finishes

PVC-u finish, available in a wide range of colours.

Benefits

- Reduces maintenance costs by preventing unsightly damage to walls caused by beds.
- Maintains a hygienic safe environment for patients and staff.
- Easy to install.
- Complement existing décor.

Extender brackets are available to suit varying projection requirements. Please contact our sales team for details.

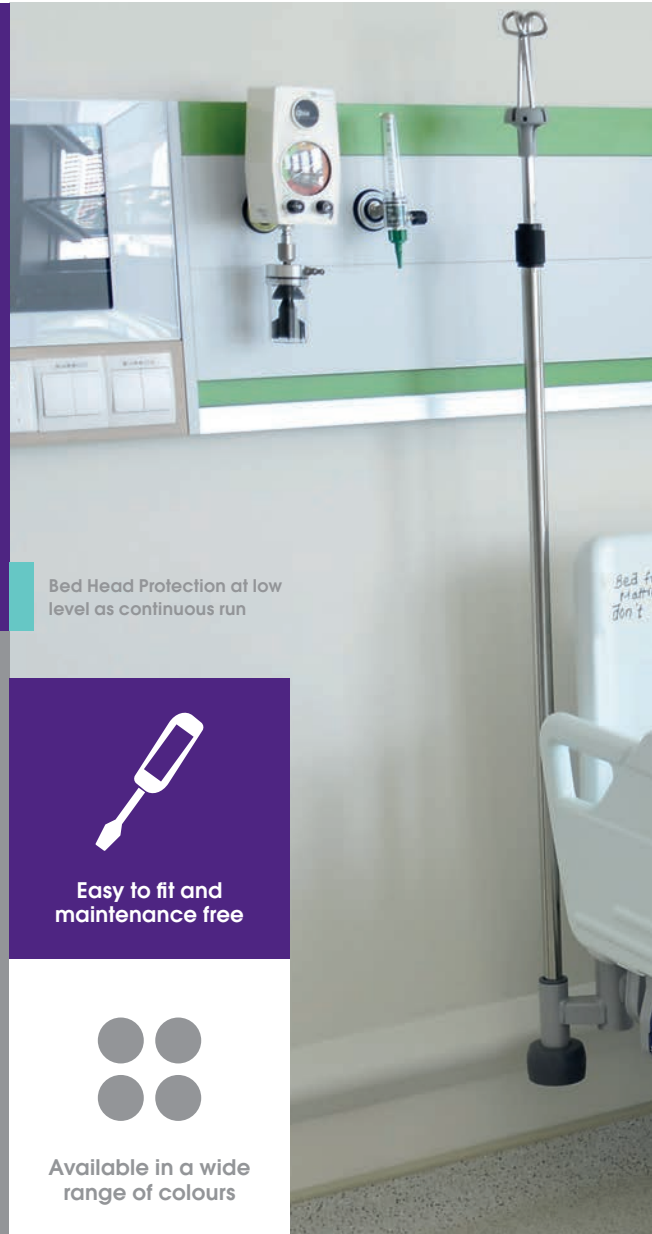

Bed Head Protection at low level as continuous run



Easy to fit and maintenance free



Available in a wide range of colours



Impact resistant





800 Bed Head Protector

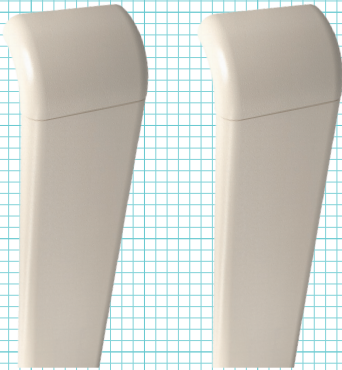

800 Bed Head Protector

Order code	Description	Width (mm)	Length (mm)
I-BH-800	Flat Profile Kit Bed Head Protector	140	915



1300 Bed Head Protector

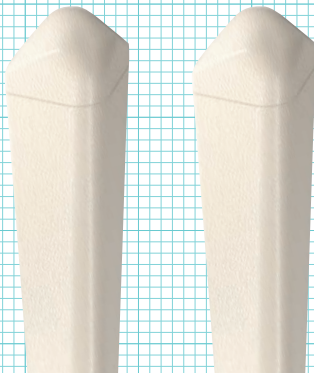

1300 Bed Head Protector

Order code	Description	Width (mm)	Length (mm)
I-BH-1300	Pyramid Profile for Flush Mounting	103	915

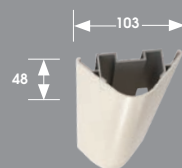

IPC[®] Corner Guards

Enhanced protection for
exposed angles.



Impact resistant



Easy to install



Available in a wide range of colours



Impact resistant

Corners are one of the most vulnerable areas of a building, and if damaged, can harbour dirt and bacteria, which may be difficult to clean. Corner Guards can be installed on damaged corners to conceal existing damage and prevent further damage.

Features

Impact resistant for light/medium to serve duty areas.

Fixing with adhesive tape or screws.

Benefits

Reduces maintenance costs by preventing wall corner damage.

Aid visually impaired people with colour contrast to the wall.

Finishes

Standard finish is PVC-u, available in a wide range of colours.



Available in a wide
range of colours



Easy to install





Self Adhesive Corner Guard 90°

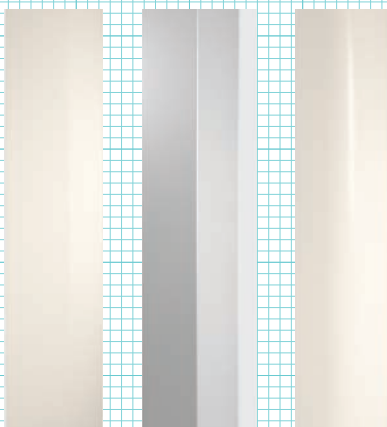

Self Adhesive Corner Guard 90°

Cost-effective PVC-u angled strip. Suitable for light to medium duty corner protection.

Order code	Description	Length (mm)
I-CG-30	90 degree 30 x 30mm Legs	1200, 2440, 3660
I-CG-50	90 degree 50 x 50mm Legs	1200, 2440, 3660
I-CG-75	90 degree 75 x 75mm Legs	1200, 2440, 3660
WCS-01-76	90 degree 76 x 76mm Legs - Intastop Door Protection Colour Range - see Protecting Doors brochure	1200, 2440, 3660



30mm, 50mm
or 75mm

160 Corner Guard

Aluminium retainer with PVC-u cover and injection moulded thermoplastic top and bottom caps. Protects against heavy to severe duty impact from wheeled traffic.

Order code	Description	Length (mm)
I-CG-1612	90 degree 51 x 51mm Legs	1220, 2440, 3660



51mm x 51mm

Custom bendable aluminium retainer with flexible top caps available.

150 Corner Guard

Aluminium retainer with PVC-u cover and injection moulded thermoplastic top and bottom caps. Protects against heavy to severe duty impact from wheeled traffic.

Order code	Description	Length (mm)
I-CG-1512	90 degree 76 x 76mm Legs	1220, 2440, 3660



76mm x 76mm

Custom bendable aluminium retainer with flexible top caps available.

130 Corner Guard

Aluminium retainer with PVC-u cover and injection moulded thermoplastic top and bottom caps. Protects against heavy to severe duty impact from wheeled traffic.

Order code	Description	Length (mm)
I-CG-1312	135 degree 76 x 76mm Legs	1220, 2440, 3660



76mm x 76mm

Custom bendable aluminium retainer with flexible top caps available.

160 Corner Guard

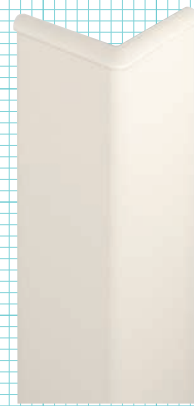

Woodland Option

150 Corner Guard



Woodland Option

130 Corner Guard

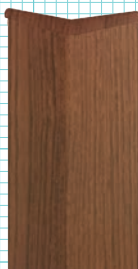

Woodland Option





Soft PVC Corner Guard

Cost-effective, enhanced protection for exposed angles.

- Suitable for medium to heavy duty applications
- Protects against impact from wheeled traffic
- Reduces maintenance costs



Reduces maintenance costs

WCG Soft PVC Corner Guard

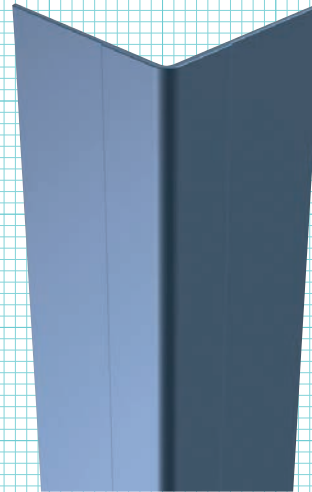

Impact resistant

Soft PVC Corner Guard

Cost-effective PVC-u angled strip. Suitable for light to medium duty corner protection.

Order code	Description	Length / Capacity
WCG-01-50	90 degree 50 x 50mm Legs	2440mm
ADC-02-G	Adhesive	310ml Gun



30mm, 50mm or 75mm

Colours

Soft PVC finishes



Blue



Light Grey



Ivory

Email our sales team: sales@intastop.com

IPC[®] Sanparrel™ Sheet

Durable, long lasting and easy to clean.

 Impact resistant

 Easy to install

 Available in a wide range of colours



Impact resistant



Sanparrel™ Sheet provides a complete range of protection for your vertical surfaces. It ensures reliable wall protection that is durable, long lasting and easy to clean.

Features

Made from PVC-u.

Thicknesses: 1mm, 1.5mm and 2mm*.

Low maintenance velvet texture.

Variety of trim accessories.

*Custom thickness, minimum requirements apply.



Variety of trim accessories

Trim Options

Damaged walls leave a lasting impression on patients and staff. Make sure the walls in your facility are conducive to a healing environment and won't leave your maintenance staff making endless repairs.

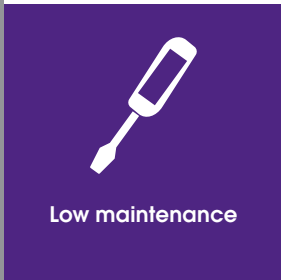

Low maintenance



Solid coloured trim

Order code	Description	Size (mm)
I-WP-406	PVC-u Sanparrel Sheet	2440 x 1220 x 1.5

A range of adhesive options are available, please contact our sales department for further details.



Faux metal trim



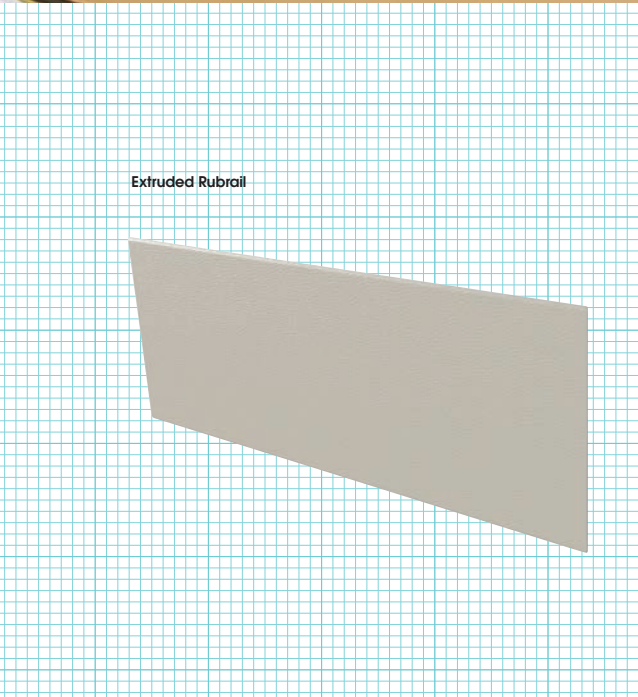

Extruded Rubrail

Extruded Rubrail

RR150 and RR200 Extruded Rubrail offer the same protection levels as Sanparrel™ Sheet.

Order code	Description	Height (mm)	Thickness (mm)	Length (mm)
RR150	Extruded Rubrail	150	2	3660
RR200	Extruded Rubrail	200	2	3660

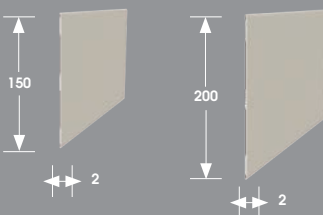

Woodland

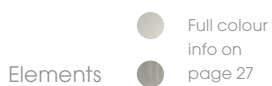

Elements

Full colour info on page 27

Aspex[®] Impact Protection Sheet

Attractive and hygienic graphics that don't fade.



Impact resistant



Bespoke design



Aspex[®] Impact Protection Sheet
When your vision becomes reality!

Impact resistant
Bespoke designs

Walls are one of the largest elements of your interiors. Give them a purpose and expand their longevity with Aspex[®] Printed Wall Protection. Your image, your branding, your statement – Aspex[®] gives you total design freedom while protecting walls from damage at the same time.

Durable – With Aspex[®], you get the high-impact durability of PETG wall protection to keep your walls safe from damage.

Vivid – Because your graphic is back-printed onto clear sheet, your image is vivid and won't get scratched over time.

Custom – You select the image*, we bring it to life! Use your own custom artwork, photography, or choose from one of our pre-designed patterns.



***Please note**

You must have the legal right to use any image you would like to have printed. Inpro respects the intellectual property rights of others and reserves the right to request verification of any image submitted for print.



Heavy Duty Rubber Wall/Corner Protection

Superior protection against severe damage.

-  Reduces maintenance costs
-  Suitable for interior and exterior environments
-  Excellent direct or indirect protection

E-Fender

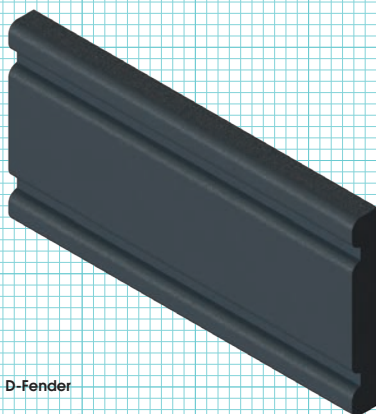

D-Fender

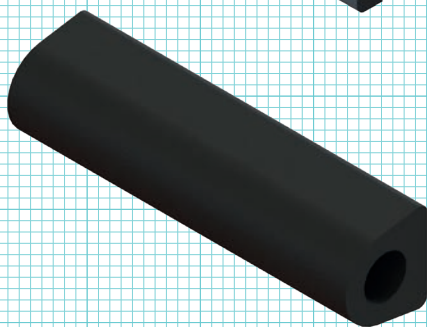

Corner Guard

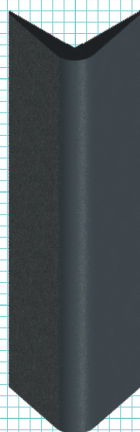

Designed to absorb, deflect and minimise the extent of wear, abrasion and impact from wheeled traffic such as trolleys, carts and vehicles, Intastop's Heavy Duty Rubber Wall/Corner Profiles offer cost-effective protection for walls, corners and columns in busy assembly and access areas.

Features

Suitable for interior and exterior environments.

Excellent direct or indirect protection.

Benefits

Reduces maintenance costs by protecting from heavy duty impact damage.

Finishes

Black Rubber.

Order details

Order code	Description	Depth x Height (mm)	Length (mm)
WRR-01	E-Fender -mechanical fix	30 x 150	3000
WRR-02	E-Fender - mechanical fix	30 x 200	3000
WRR-03	D-Fender - mechanical fix	97 x 107	3000
WRR-04	Corner Guard - mechanical fix/adhesive fix	100 x 100	3000



Protecting Doors

Whether new or retro-fit we offer solutions to reduce maintenance costs, increase the lifespan of the door and frame whilst retaining fire integrity and aesthetics.

Antibacterial Impact Protection Sheet

Provides an impact resistant surface to walls, doors and cupboards.



Protecting People

Developing products to Protect People is a large part of what we do. From door top alarms to anti-barricade products we are able to provide a full range of anti-ligature solutions aimed at protecting service users and staff.

SECURA™ Stop

Quick release emergency response in an event of a barricade.

SECURA™ Solutions

Intastop's range of anti-ligature solutions.

“Excellent presentation which showcased the product uses well.”

Karen Byard, Fire Officer
Bradford District Care NHS Foundation Trust

“Suggest fish and chips for lunch as improvement! Excellent set up and good insight. Great presentation with vast knowledge and superb insight.”

Phil Tyas
Project Officer, SWYPT



training centre

Visit our training and innovation centre to see first hand how our range of products and solutions can provide you with cost saving protection requirements.



IPC[®] Product Characteristics

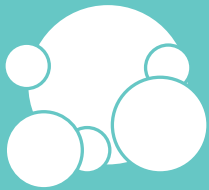

Chemical Resistance

Tested in accordance with BS EN ISO 175:2010, BS27828: Method 830A:1999, Plastics – Methods of test for the determination of the effects of immersion in liquid chemicals.

The results show that the products as tested are resistant to most commonly used chemical solutions.

Bacterial Resistance

Tested in accordance with BS EN ISO 846:1997, Plastics – Evaluation of the action of microorganisms.

The results show that the products as tested did not support bacterial growth.

Fungal Resistance

Tested in accordance with BS EN ISO 846:1997, Plastics – Evaluation of the action of microorganisms.

The results show that the products as tested did not support fungal growth.



Fire Performance

Tested in accordance with EN ISO 11925-2:2010 and EN 13823:2010+A1:2014 and classified according to EN 13501-1:2007+A1:2009 as - Reaction to fire classification: B – s3, d0.



VOC Emissions

Tested in accordance with BS EN ISO 16000-9:2006, Indoor air – Part 9: Determination of the emission of volatile organic compounds from building products and furnishing – Emission test chamber method. The results show that the products as tested meet low emissions requirements.

The colour range

Standard solid colours

IPC® Handrails & Combi-Rails

IPC® Wall Guards

IPC® Bed Head Protection

IPC® Corner Guards

IPC® Sanparrel™ Sheet

Choice of smooth or textured finish available in a variety of colours to offer a wide range of contrasting, co-ordinating and harmonising solutions.

*Readily available from stock.

	Designer White 0101 LRV 78.7		White Sand 0103 LRV 77.0		Clam Shell 0154 LRV 71.1
	Eggshell 0111 LRV 68.4		Burlap 0252 LRV 43.4		Light Beige* 0109 LRV 70.5
	Beeswax 0249 LRV 56.9		Canary 1050 LRV 77.77		Sunny Day 1051 LRV 69.84
	Honey 1053 LRV 34.21		Sherbet 1052 LRV 51.3		Mandarin 1054 LRV 36.69
	Truffle 0284 LRV 9.6		Cabernet 0241 LRV 7.7		Cardinal 0236 LRV 11.2
	Mint 1056 LRV 55.21		Aloe 1057 LRV 59.33		Clover 1058 LRV 19.82
	Crystal Jade* 0187 LRV 34.8		English Green* 0125 LRV 16.6		Cloudy 1059 LRV 49.09
	Buoyant Blue* 0132 LRV 25.5		Periwinkle 0272 LRV 19.5		Point Blue* 0165 LRV 8.9
	Purple Haze 0171 LRV 15.8		Orchid 1055 LRV 17.36		Taupe 0113 LRV 52.0
	River Rock 0351 LRV 22.4		Silver 0105 LRV 48.1		Dove Grey* 0106 LRV 37.1
	Pewter Grey* 0107 LRV 17.5		Sharkskin 0350 LRV 42.2		Castle 0256 LRV 10.8
	Black 0152 LRV 4.5				

Woodland patterns

IPC® Handrails & Combi-Rails

IPC® Wall Guards

IPC® Corner Guards

IPC® Sanparrel™ Sheet

	Clear Natural Maple 0531 LRV 57.7		Applewood 0537 LRV 30.5		Honeynut 0535 LRV 15.9
	Boston Cherry 0534 LRV 9.2		Santa Rosa 0532 LRV 37.3		American Walnut 0555 LRV 6.3

Woodlands offer a wood grain appearance without the maintenance of traditional wood.

Elements patterns

IPC® Sanparrel only

	Brushed Silver 5E025 LRV 37.1		Brushed Nickel 5E026 LRV 17.5
---	---	--	---

Protecting Doors, People & Places



Intastop Ltd
Unit 12 Data Drive
South Kirkby Business Park
Pontefract
WF9 3FD
United Kingdom

Tel: +44 (0)1302 364 666
Fax: +44 (0)1302 364 777
sales@intastop.com
www.intastop.com

Follow us on:
Twitter, Facebook, LinkedIn & Instagram



V5 August 2023